

Klappdeckel mit den 4 Schrauben auf das Blech montieren  
 Mount snap cap with the 4 screws on the plate

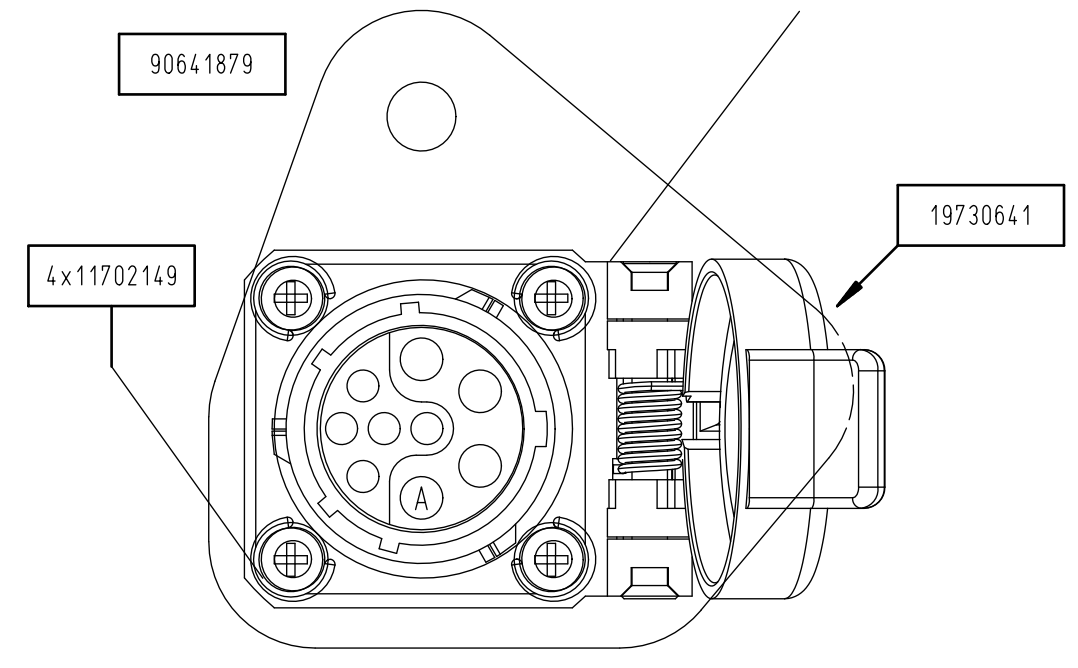

Einbaulage Steckverbinder X66  
 Mounting orientation of connector X66

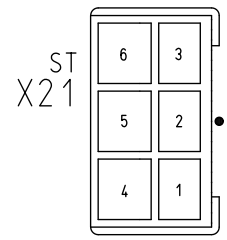

19729102

|          |   |      |       |    |    |    |
|----------|---|------|-------|----|----|----|
| 19724020 | 1 | 2.5  | A1525 | 3  | WH | 80 |
| 19724020 | 2 | 2.5  | A3100 | 10 | WH |    |
| 19724020 | 3 | 2.5  | A1526 | 3  | WH |    |
| 19724020 | 4 | 2.5  | A3100 | 11 | WH |    |
| 19724053 | 5 | 0.75 | A3022 | 17 | WH |    |
|          | 6 |      |       |    |    |    |

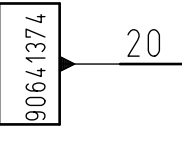
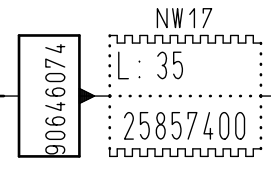
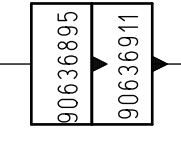
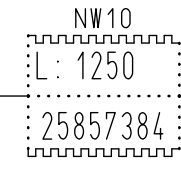
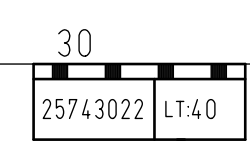

|    |       |    |      |   |          |
|----|-------|----|------|---|----------|
| WH | A1525 | 3  | 2.5  | A | 19721406 |
| WH | A3100 | 10 | 2.5  | B | 19721406 |
| WH | A1526 | 3  | 2.5  | C | 19721406 |
| WH | A3100 | 11 | 2.5  | D | 19721406 |
| WH | A3022 | 17 | 0.75 | E | 19721422 |
|    |       |    |      | F |          |
|    |       |    |      | G |          |
|    |       |    |      | H |          |
|    |       |    |      | L |          |

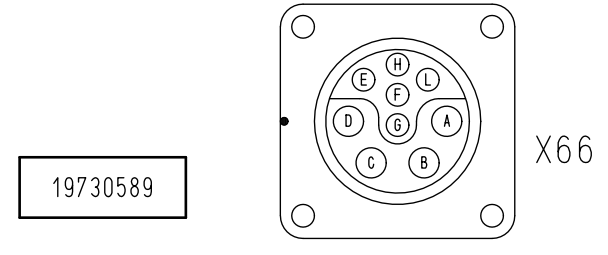

28030104

**Kontakte des X66 mit Nyogel 760G bestreichen**  
**Coat contacts of X66 with Nyogel 760G**

| Toleranzen / tolerances |            |
|-------------------------|------------|
| 0 - 100 mm              | - 0/+10 mm |
| 101 - 500 mm            | -10/+10 mm |
| 501 - 2000 mm           | -10/+20 mm |
| > 2000 mm               | -10/+30 mm |

The tolerances are made for individual measurements and for the sum of several measurement

All housings with internal length

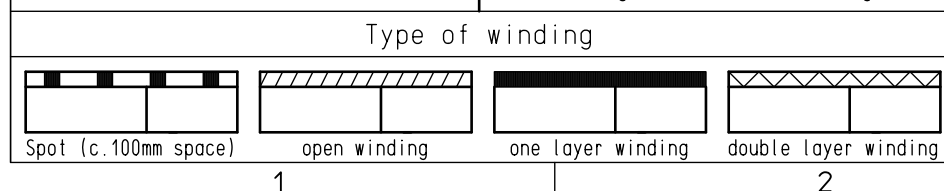

|    |  |     |                |            |          |      |          |        |      |                        |            |  |  |   |  |                |           |          |              |         |
|----|--|-----|----------------|------------|----------|------|----------|--------|------|------------------------|------------|--|--|---|--|----------------|-----------|----------|--------------|---------|
| 1  |  | ./. |                | 3327-00    | 18.07.16 | DK   | 2015     | Date   | Name | Citymaster 1600        | Name       | Kabelbaum W33 (Steckd. 9pol. Frontanbau) |  | Hako GmbH<br>D-23840 Bad Oldesloe                           |  | Drawing Number |           |          |              |         |
| A2 |  | No. | Number appears | Change No. | Date     | Name | Standard | 01.04. | DK   | Replacem. for same no. | Change No. | 3002-16                                  |  | For this drawing we reserve all rights (acc. DIN ISO 16016) |  | KABI 472       | Type 1491 | Dep. ELK | No. of Sh. 2 | Sheet 1 |

All parts have to be in conformity to IEC 60335-1/-2-72  
 All housings have to be labeled with device tags

W33

|                             |  |   |  |  |  |  |  |  |  |  |  |
|-----------------------------|--|---|--|--|--|--|--|--|--|--|--|
| cutting list-No. : 97132740 |  | cutting list Kabelbaum W33 (Steckd. 9pol. Frontanbau) |  |  |  |  |  |  |  |  |  |
|-----------------------------|--|---|--|--|--|--|--|--|--|--|--|

| wire  | Sub | part-No. contact 1 | part-No.comp.part | marking 1 | wire     | cr. sec. | length | colour | marking 2 | part-No. contact 2 | part-No.comp.part |
|-------|-----|--------------------|-------------------|-----------|----------|----------|--------|--------|-----------|--------------------|-------------------|
| A1525 | 3   | 19724020           |                   | X21/ST/1  | 26210112 | 2,5      | 1475   | WH     | X66/A     | 19721406           |                   |
| A1526 | 3   | 19724020           |                   | X21/ST/3  | 26210112 | 2,5      | 1475   | WH     | X66/C     | 19721406           |                   |
| A3022 | 17  | 19724053           |                   | X21/ST/5  | 26210310 | 0,75     | 1475   | WH     | X66/E     | 19721422           |                   |
| A3100 | 10  | 19724020           |                   | X21/ST/2  | 26210112 | 2,5      | 1475   | WH     | X66/B     | 19721406           |                   |
| A3100 | 11  | 19724020           |                   | X21/ST/4  | 26210112 | 2,5      | 1475   | WH     | X66/D     | 19721406           |                   |

|     |                      |          |          |      |       |        |      |                        |  |  |                 |
|-----|----------------------|----------|----------|------|-------|--------|------|------------------------|--|--|-----------------|
| 1   | /.                   | 3327-00  | 18.07.16 | DK   | 2016  | date   | name | Citymaster 1600        | <br>Hako GmbH<br>D-23840 Bad Oldesloe | Kabelbaum W33 (Steckd. 9pol. Frontanbau) |                 |
|     |                      |          |          |      | drawn | 01.04. | DK   | replaced by : same no. |  |  |                 |
|     |                      |          |          |      | check |        |      | rev. No. : 3002-16     |  | type : 1491                              | <b>97132740</b> |
| No. | changed wire/Sub-No. | Rev.-No. | date     | name |       |        |      |                        |  |  |                 |

Material: 97132740 wiring harness  
 Index: 01  
 Change Number: 3327-00

| Material | Item | Line | Component       | Object description                      | Material Description                     | Comp. Qty (CUn) | Un       | Internal Comment                        |
|----------|------|------|-----------------|---|--|-----------------|----------|---|
| 97132740 | 10   | 1    | <b>11702149</b> | Schraube DIN 7500-PE M3x8-St A2B        | screw                                    |                 | 4 PC     |   |
| 97132740 | 10   | 2    |                 |   |  |                 |          | Hr. Beckmann                            |
| 97132740 | 20   | 1    | <b>19721406</b> | BU-Kont. RT 2,5mm (2,5-3,5)             | socket-cont. RT 2,5mm (2,5-3,5)          |                 | 4 PC     |   |
| 97132740 | 20   | 2    |                 |   |  |                 |          | Fa.Amphenol Nr.SS12A1T                  |
| 97132740 | 30   | 1    | <b>19721422</b> | BU-Kont. RT 1,6mm (0,75-1,5)            | socket-cont. RT 1,6mm (0,75-1,5)         |                 | 1 PC     |   |
| 97132740 | 30   | 2    |                 |   |  |                 |          | Fa. Amphenol Nr.SS16M1G10               |
| 97132740 | 40   | 1    | <b>19724020</b> | Flachstecker 6,3x0,8 (1,5-2,5)          | tab-cont. 6,3x0,8 (1,5-2,5)              |                 | 4 PC     |   |
| 97132740 | 40   | 2    |                 |   |  |                 |          | Fa. Lear Nr. 25054.213.111              |
| 97132740 | 50   | 1    | <b>19724053</b> | Flachstecker 6,3x0,8 (0,5-1,0)          | tab-cont. 6,3x0,8 (0,5-1,0)              |                 | 1 PC     |   |
| 97132740 | 50   | 2    |                 |   |  |                 |          | Fa. Lear Nr.25297.123.178               |
| 97132740 | 60   | 1    | <b>19729102</b> | ST-Gehäuse 6-pol FASTIN-ON 6.3          | male-housing 6-pole FASTIN-ON 6.3        |                 | 1 PC     |   |
| 97132740 | 60   | 2    |                 |   |  |                 |          | Fa. Püplichhuisen Nr. 97418 562.501     |
| 97132740 | 70   | 1    | <b>19730589</b> | Gerätedose für Buchsenkontakt 9pol.     | wall mounting receptacle housing 9pol.   |                 | 1 PC     |   |
| 97132740 | 70   | 2    |                 |   |  |                 |          | Fa. Amphenol Nr. RT001609SNH-Ni         |
| 97132740 | 80   | 1    | <b>19730641</b> | Klappdeckel Größe 16                    | flap lid                                 |                 | 1 PC     |   |
| 97132740 | 80   | 2    |                 |   |  |                 |          | Fa. Amphenol Nr. PT-SCC16               |
| 97132740 | 90   | 1    | <b>25743022</b> | Gewebeband 9mm schwarz                  | textile tape 9mm black                   |                 | 0,04 M   |   |
| 97132740 | 90   | 2    |                 |   |  |                 |          | Fa.Beiersdorf AG                        |
| 97132740 | 90   | 3    |                 |   |  |                 |          | Nr.4545-04-33 AF 18 PV 7                |
| 97132740 | 90   | 4    |                 |   |  |                 |          | umgestellt aus Qualitätsgründen auf     |
| 97132740 | 90   | 5    |                 |   |  |                 |          | Coroplast 8110                          |
| 97132740 | 100  | 1    | <b>25857384</b> | Wellschlauch NW10 PPmod UFW ungeschl.   | Corrugated tube NW10 PPmod UFW unslit    |                 | 1,25 M   |   |
| 97132740 | 100  | 2    |                 |   |  |                 |          | Fa. Schlemmer Nr. 1949210               |
| 97132740 | 110  | 1    | <b>25857400</b> | Wellschlauch NW17 PPmod UFW ungeschl.   | Corrugated tube NW17 PPmod UFW unslit    |                 | 0,04 M   |   |
| 97132740 | 110  | 2    |                 |   |  |                 |          | Fa. Schlemmer Nr. 1949217               |
| 97132740 | 120  | 1    | <b>26210112</b> | PVC-Fahrzeugleitung FLRY-B 1x2,5 weiss  | PVC-automotive cable FLRY-B 1x2,5 white  |                 | 5,9 M    |   |
| 97132740 | 120  | 2    |                 |   |  |                 |          | Fa. NKT Art.: AP040025BNNNNAN           |
| 97132740 | 120  | 3    |                 |   |  |                 |          |   |
| 97132740 | 120  | 4    |                 |   |  |                 |          | DIN 72551 / ISO6722 FLRY-B              |
| 97132740 | 130  | 1    | <b>26210310</b> | PVC-Fahrzeugleitung FLRY-B 1x0,75 weiss | PVC-automotive cable FLRY-B 1x0,75 white |                 | 1,48 M   |   |
| 97132740 | 130  | 2    |                 |   |  |                 |          | Fa. NKT Art.: AP040007BNNNNAN           |
| 97132740 | 130  | 3    |                 |   |  |                 |          |   |
| 97132740 | 130  | 4    |                 |   |  |                 |          | DIN 72551 / ISO6722 FLRY-B              |
| 97132740 | 140  | 1    | <b>28030104</b> | Schmierfett NYOGEL 760G                 | grease NYOGEL 760G                       |                 | 0,01 PCD |   |
| 97132740 | 140  | 2    |                 |   |  |                 |          | Fa. Nye Lubricants, Inc Nr. NYOGEL 760G |
| 97132740 | 150  | 1    | <b>90636895</b> | Einlegereduzierung 13-10                | Reducer 13-10                            |                 | 1 PC     |   |
| 97132740 | 150  | 2    |                 |   |  |                 |          | Fa. Schlemmer Nr. 7807280               |
| 97132740 | 150  | 3    |                 |   |  |                 |          |   |
| 97132740 | 160  | 1    | <b>90636911</b> | Einlegereduzierung 17-13                | reducer 17-13                            |                 | 1 PC     |   |
| 97132740 | 160  | 2    |                 |   |  |                 |          | Fa. Schlemmer Nr. 7807283               |
| 97132740 | 160  | 3    |                 |   |  |                 |          |   |
| 97132740 | 170  | 1    | <b>90641374</b> | Wellrohrmatur NW17                      | tube for armature NW17                   |                 | 1 PC     |   |

Material: 97132740 wiring harness

Index: 01

Change Number: 3327-00

| Material | Item | Line | Component       | Object description         | Material Description      | Comp. Qty (CUn) | Un   | Internal Comment |         |
|----------|------|------|-----------------|----------------------------|---------------------------|-----------------|------|------------------|---------|
| 97132740 | 180  | 1    | <b>90641879</b> | Lasche                     | FW 90641879 Lasche        |                 | 1 PC |                  |         |
| 97132740 | 190  | 1    | <b>90646074</b> | Verbindung 90° Winkel NW17 | connection 90° angle NW17 |                 | 1 PC |                  |         |
| 97132740 | 190  | 2    |                 |                            |                           |                 |      | Fa.Schlemmer     |         |
| 97132740 | 190  | 3    |                 |                            |                           |                 |      |                  | 7807400 |